

0.0 GUIA “Como instalar tedee, fechadura inteligente na sua porta”



CONCEITO

Um fechadura inteligente instala-se na fechadura da porta, e permite o controlo - manual e automático - da abertura e fecho da porta através de smartphone, smartwatch, assistente de voz, teclado pin etc. com notificações sobre o estado da fechadura.



Como se Instala a tedee na porta? Por fora...



POR FORA nada muda!

Por fora não existe qualquer alteração aparente.

A porta continuará a poder ser aberta através de chave, além da fechadura inteligente



Como se Instala a tedee na porta? Por DENTRO...

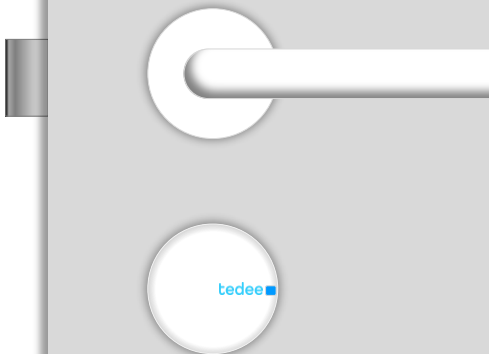

POR DENTRO

A tedee instala-se por dentro com um **cilindro adaptado** ou com um **adaptador** sobre o cilindro existente.

Sem cabos, sem fios, sem pilhas.



Guia de Compatibilidade

Antes de adquirir a sua fechadura inteligente, deve **verificar se o conjunto da sua fechadura e porta** são compatíveis.

Nas paginas seguinte ilustramos **PASSO A PASSO** as seguintes verificações de compatibilidade:

[FORMATO do Cilindro e de Fechadura](#)
[ABERTURA para FORA / DENTRO](#)
[MOVIMENTO da chave + maçaneta](#)
[Instalação com ADAPTADOR](#)
[Instalação com EURO-CILINDRO](#)

Em cada passo verifique o resultado da porta/fechadura que poderá ser:

INCOMPATÍVEL
Não é possível instalar a **tedee** nesta porta

Contate-nos para avaliar alternativas

TALVEZ..
Requer confirmação de detalhes.

Contate-nos para avaliar detalhes

COMPATÍVEL
É possível instalar a **tedee** nesta porta.

Contate-nos para adquirir a sua **tedee**

Use este símbolo para navegar ao longo deste guia



1

Formato do CILINDRO e da FECHADURA

Verifique o tipo de cilindro da fechadura. Qual é o formato?

Verifique se a maçaneta/puxador e o cilindro fazem parte do mesmo espelho/ferragem ou são separados?

Use as imagens abaixo para determinar o seu caso



**EURO-CILINDRO
EUROPEAN**

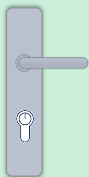

**NÓRDICO
NORDIC**

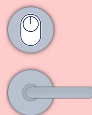
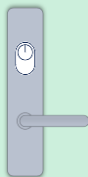

COMPATÍVEIS >
CONTINUAR

INCOMPATÍVEL >
ALTERNATIVAS

2

A PORTA abre para FORA / DENTRO

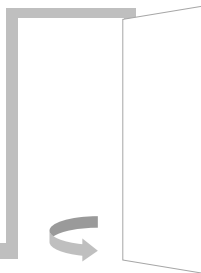

Se a porta **ABRE PARA DENTRO**, o modo de abertura é **COMPATÍVEL** com tedee

Mas tenha em atenção que ao abrir a porta pode eventualmente bater com a tedee na parede se ficar mais saliente do que o puxador existente. Isto resolve-se facilmente com um batente no pavimento.

COMPATÍVEL >
CONTINUAR

Se a porta **ABRE PARA FORA** é necessário **confirmar se a tedee não bate na ombreira**, ao abrir.

Na **próxima página** confira as dimensões, pelo de dentro de casa, para garantir compatibilidade.

- Dx – distância centro da fechadura à ombreira (cm)
- Dy - distância entre ombreiras (cm)

TALVEZ >
MAIS DETALHES

3

A PORTA abre para FORA

2/2

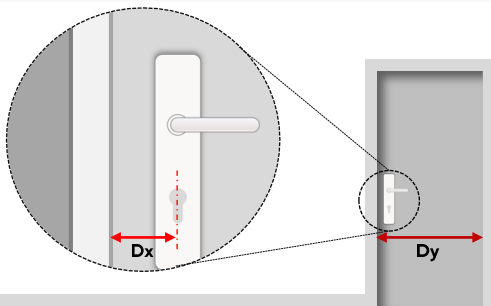
**Dx maior que 3,5 ou Dy maior que 90****COMPATÍVEL**
CONTINUAR**Dx entre 3,0 e 3,5 e Dy menor que 90****TALVEZ**
VERIFICAR**Dx menor que 3,0****INCOMPATÍVEL**
ALTERNATIVAS

MOVIMENTO da Chave + Maçaneta

Se para abrir os ferrolhos da fechadura for necessário levantar a maçaneta então a fechadura é de movimento composto

Qual é o tipo de movimento da sua fechadura?

Compare estas imagens com o **movimento que faz quando abre a sua porta**

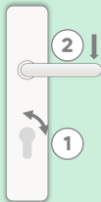
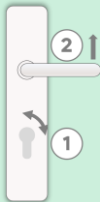
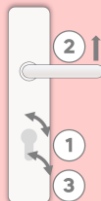
MOVIMENTO
NORMALMOVIMENTO
COMPOSTO tipo 1COMPATÍVEL >
CONTINUARMOVIMENTO
COMPOSTO tipo 2INCOMPATÍVEL >
ALTERNATIVAS

Método de Instalação da tedee

Depois de verificadas as condições anteriores de compatibilidade, é necessário agora definir o método de instalação



Todos os formatos de Cilindro podem ser instalados com **ADAPTADOR** de acordo com o formato.

Mantem as chaves físicas que já existem!!

INSTALAR COM ADAPTADOR
CONTINUAR



O formato Euro-Cilindro também pode ser instalado com **CILINDRO ADAPTADO**
Terá um novo conjunto de chaves físicas

INSTALAR COM NOVO CILINDRO
CONTINUAR

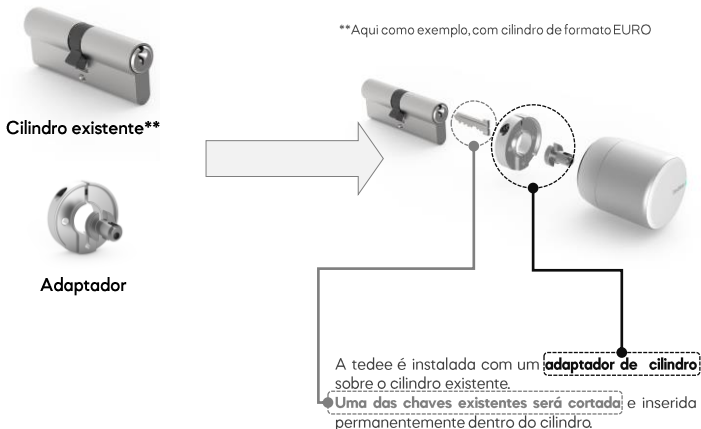

Instalação com ADAPTADOR
CONCEITO

É necessário **verificar 2 condições** muito importantes para garantir que é possível instalar a tedee com o adaptador
Na página seguinte veja quais são essas condições

TALVEZ
CONTINUAR



6.2

Instalação com ADAPTADOR VALIDAR

Para instalar com adaptador é necessário que:

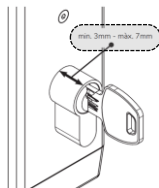

CILINDRO SALIENTE entre 3 a 7 mm

Esta saliência é necessária para apertar o ADAPTADOR ao cilindro existente

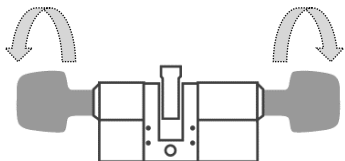

CILINDRO ANTIPÂNICO

Abre a porta por fora com a chave metida do dentro, então o cilindro é antipânico.

O cilindro existente **CUMPRE** com estas duas condições
A **tedee** será instalada com **ADAPTADOR**.

INSTALAR COM ADAPTADOR
CONCLUIR



O cilindro existente **NÃO CUMPRE** com estas duas condições
A **tedee** será instalada com **Euro-Cilindro ADAPTADO**

INSTALAR COM NOVO CILINDRO
CONTINUAR



Packs tedee ADAPTADOR



adapter



bridge



keypad



bridge+keypad

... junto à porta



... longe de casa



... código pin



... smartphone



... smartwatch



... siri, homekit



... web browser



... alexa, google



... smarthome gateways



TERMINAR
FINAL



PEDIR ORÇAMENTO
E-MAIL



Instalação com EURO-CILINDRO CONCEITO

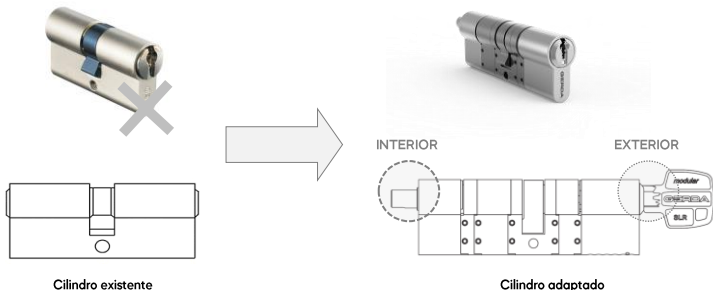

A tedee é instalada com um **CILINDRO ADAPTADO** substituindo o cilindro existente.

A fechadura terá um novo cilindro e um novo conjunto de chaves

O cilindro tedee possui, na extremidade **exterior**, uma ranhura para usar com **chave normal**, se necessário.

Na extremidade **interior**, o cilindro tedee, está equipado com **um pino** de dimensões e formato adequado para fixar a tedee

Nas páginas seguintes veja alguns detalhes importantes acerca do cilindro, nomeadamente o tipo de mecanismo e dimensões.

INSTALAR COM NOVO CILINDRO
CONTINUAR >

8.2

Instalação com EURO-CILINDRO MECANISMO

O MECANISMO do **CILINDRO ADAPTADO** tedee pode ser de 2 tipos: CAMBOTA ou RODA DENTADA.

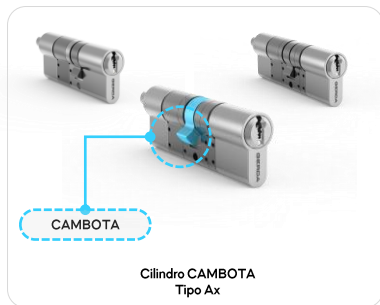

Normalmente usada EM fechaduras Euro-
Cilindro da generalidade das marcas
Cilindro Tedee Tipo Ax.

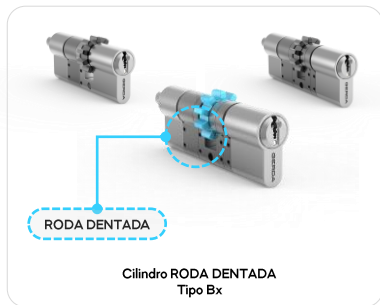

Normalmente usada em fechaduras Euro-
Cilindro da marca **MUL-T-LOCK**
Cilindro Tedee Tipo Bx.

A seguir irá medir o cilindro ou a fechadura existente.

INSTALAR COM NOVO CILINDRO
CONTINUAR >

Instalação com EURO-CILINDRO

Dimensões do cilindro - DETALHES

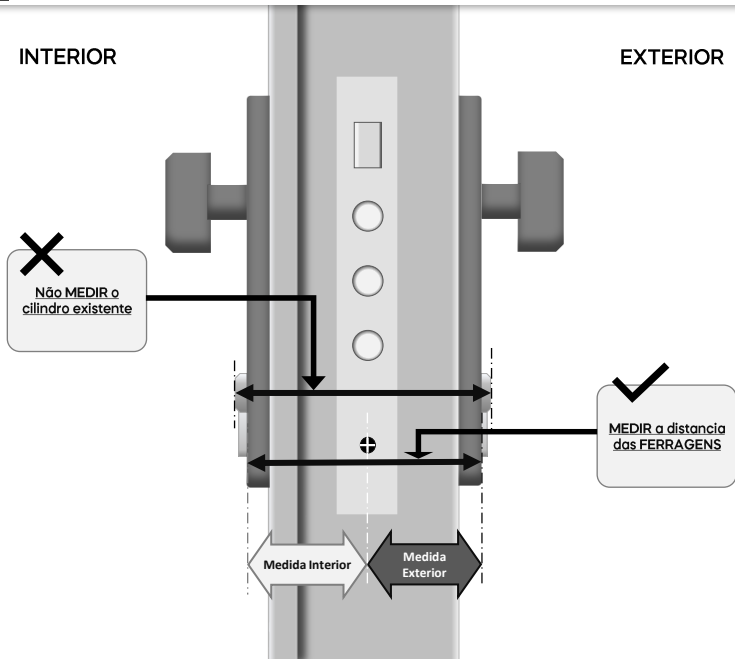

8.3
2/4

Instalação com EURO-CILINDRO

Dimensões do cilindro - INTERIOR

INTERIOR

EXTERIOR

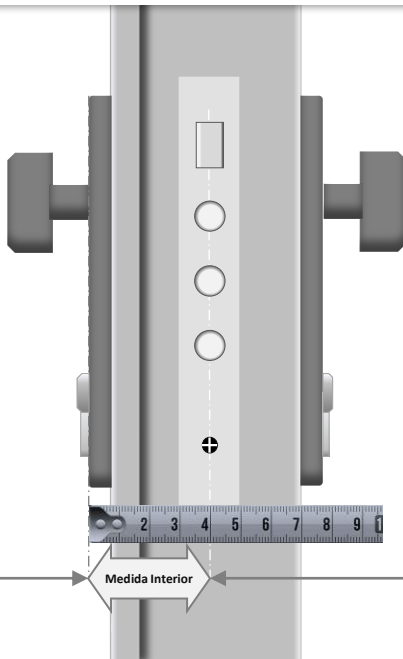

1. Medir desde a superfície da ferragem, do lado de dentro da porta..

2 .. Até ao centro do parafuso de fixação (ou dos ferrolhos)

Medida Interior



8.3
3/4

Instalação com EURO-CILINDRO Dimensões do cilindro - EXTERIOR

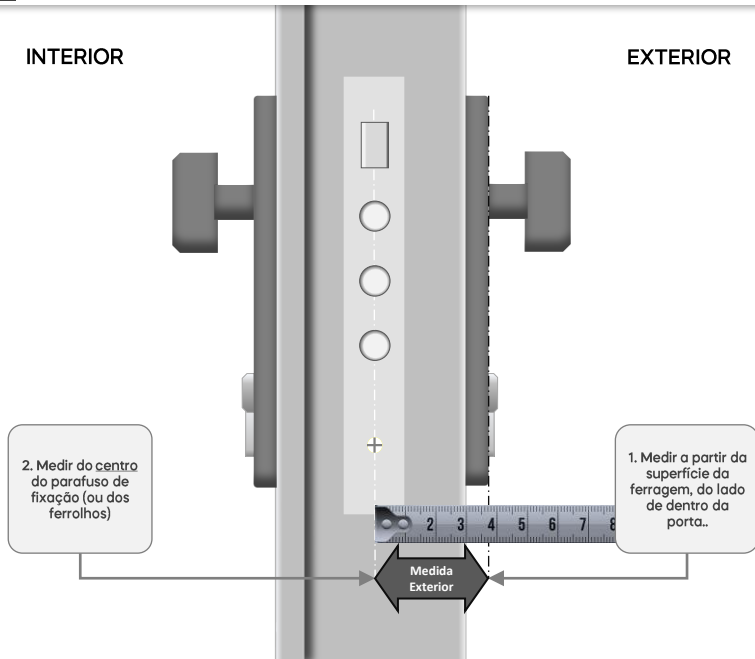

8.3
4/4

Instalação com EURO-CILINDRO

Dimensões do cilindro - AJUSTAR

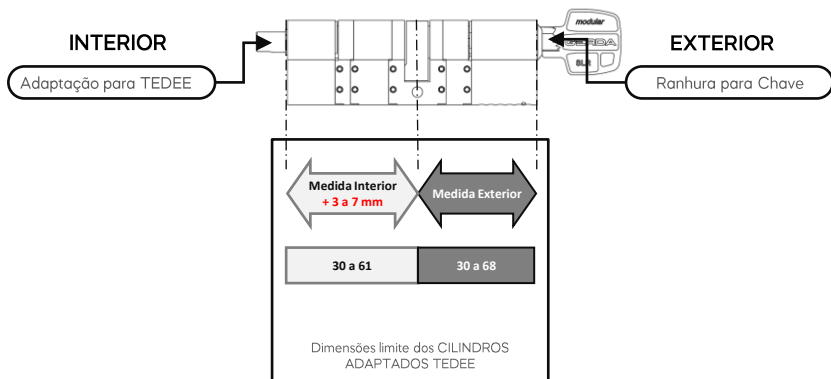

Se dimensões obtidas estão dentro dos limites apresentados,
a **tedee** será instalada com **EURO CILINDRO ADAPTADO normal**

COM CILINDRO NORMAL
CONCLUIR



Se dimensões obtidas estão dentro dos limites apresentados,
a **tedee** será instalada com **EURO CILINDRO ADAPTADO especial**

COM CILINDRO ESPECIAL
CONTACTAR



Packs tedee CILINDRO



cylinder



bridge



keypad



bridge+keypad

... junto à porta



... longe de casa



... código pin



... smartphone



... smartwatch



... siri, homekit



... web browser



... alexa, google



... smarhome gateways



MAIS QUESTÕES
CONTACTE



PEDIR ORÇAMENTO
E-MAIL



Dúvidas ou Questões por resolver?

Conseguiu a informação que procurava?

Este documento não foi suficientemente claro?

Ficou com alguma dúvida acerca da informação que procurava?

O seu caso não consta deste guia?

Fale connosco e vamos prontamente procurar elucidar as suas dúvidas ou questões:

Email : info@tedee.pt ou info@smartlock.pt

Telef.: +351 914 070 180 (chamadas e whatsapp)